

COMPOSICIONES CON PUF-TUMBONA PARTIDA (PT)

IZQUIERDA

DERECHA

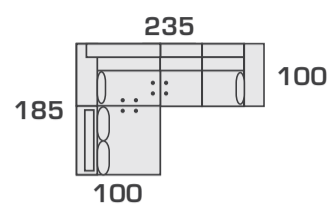

RP.2P-I

RP.2P-D

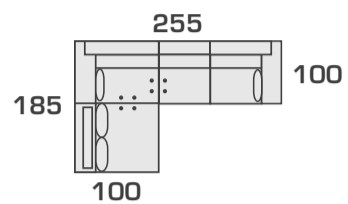
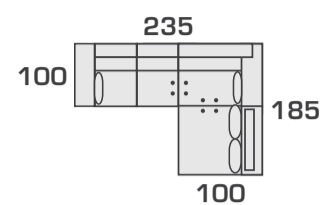

RP.2N-I

RP.2N-D

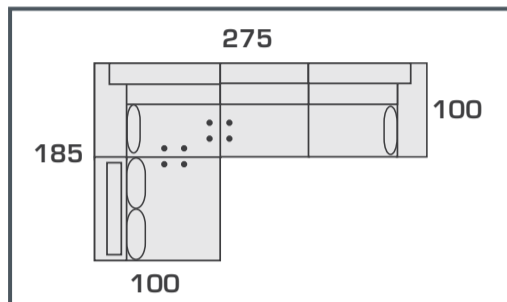
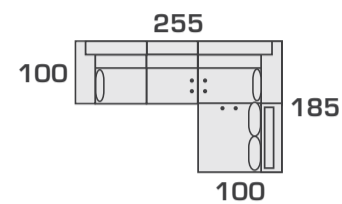

**SOLO ES REVERSIBLE
ESTA MEDIDA (2,75)**

RP.2M-I REVERSIBLE ↔ RP.2M-D REVERSIBLE

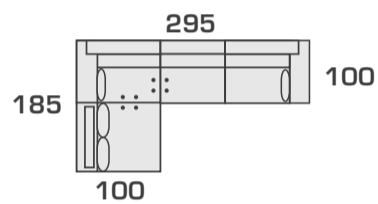
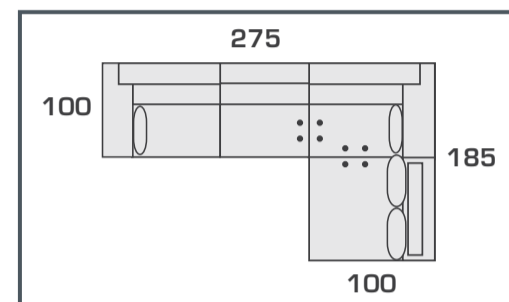

RP.2G-I

RP.2G-D

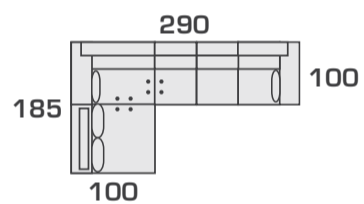
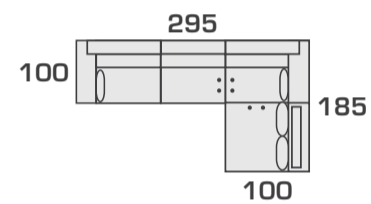

RP.3P-I

RP.3P-D

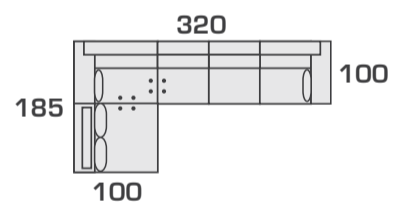
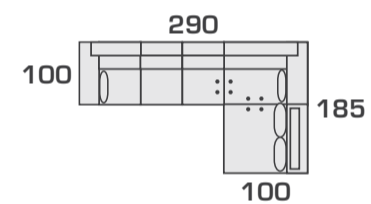

RP.3N-I

RP.3N-D

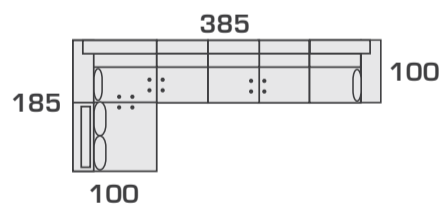
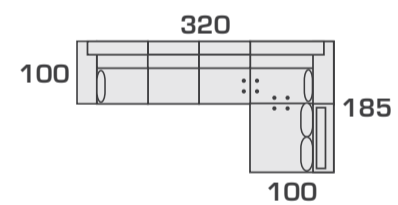

RP.4N-O

RP.4N-D

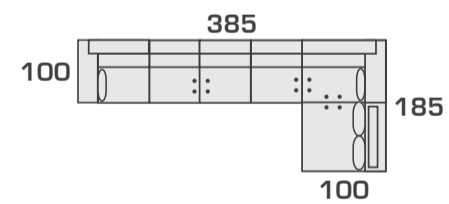

VISCOELÁSTICA



NOVEDAD

- ELEVADA DENSIDAD
- ADAPTACIÓN TERMOSENSIBLE
- FAVORECE LA CIRCULACIÓN SANGUÍNEA
- LENTA RECUPERACIÓN Y DURACIÓN GARANTIZADAS
- EXTRAORDINARIA SENSACIÓN DE CONFORT Y DESCANSO